

# Guidance for Safe Work

## Driveway Swing Gate

10FT\12FT\14FT\16FT\18FT\20FT

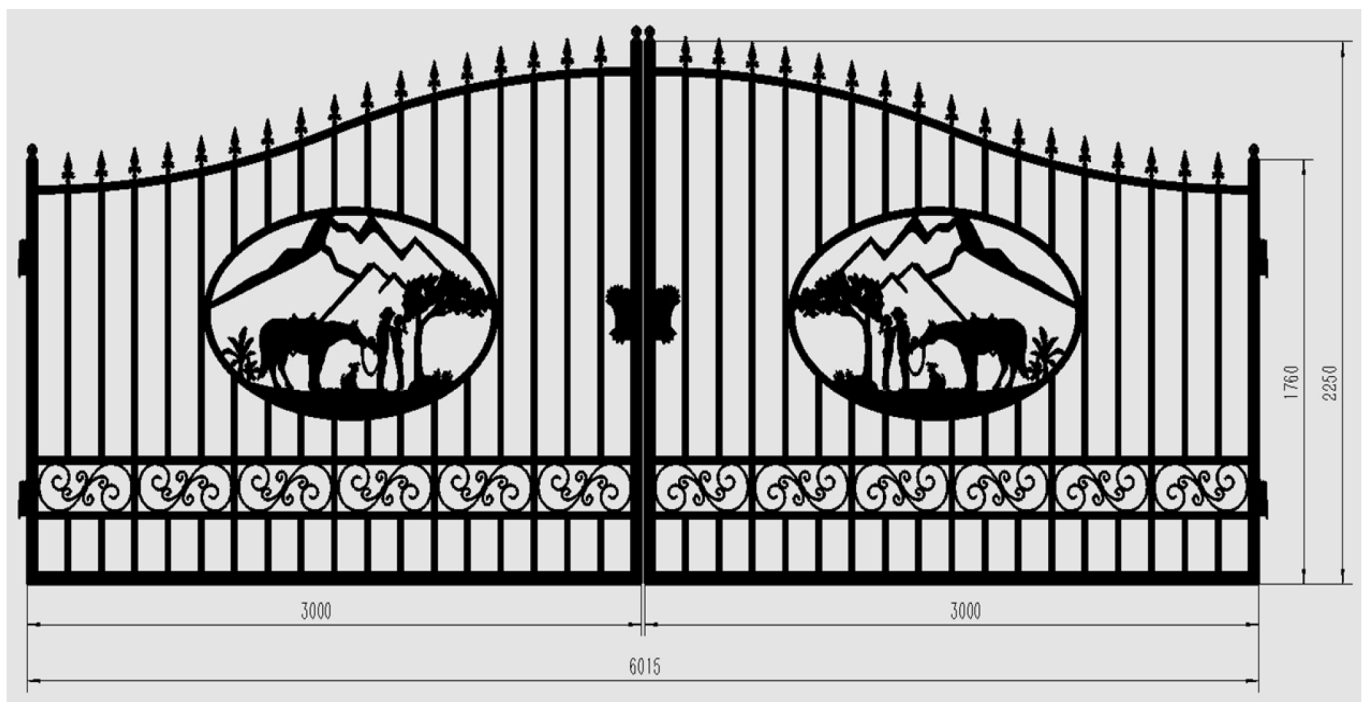

**Welded steel tube construction, sand blasted and powder coated**

Save this manual for future reference!

# THANK YOU!

Our sincere appreciation to you on the purchase of a quality steel drivegate. Product experience is the cornerstone of our company, and our goal is to provide you with a good product that will give you years of satisfaction and operation.

Our record of successful and satisfied customers is evidence of the concern for quality and designed strength that we place into each and every product we build.

As this manual expresses the need for safe operation of your acquisition. It is important that you and the others who in charge of fixing and using this product become familiar with the operation, maintenance and safety instructions found in this manual, Add some common sense to the items mentioned in these manuals as the recipe for safe operation.

Sincerely,  
Management & Employees

# Features

Manual Driveway Steel Swing Gates are a easy and affordable way to secure a road way!  
It can be used in rural, residential, commercial, military and forestry applications.

Double Swing

Easy to Install.

In a bolt to surface model

Available slide bolt locking mechanism accepts your padlock or pin lock.

Available Receiver Post which has slide channel to accept the gate slide bolt so that it can be padlocked or pin locked securely in the open position.

You may purchase our bolt on channel so that you can attach it to your own fence post or receiver post.

Welded steel tube construction, sand blasted and powder coated

# Specifications

10FT\12FT\14FT\16FT\18FT\20FT

Specifications

2.25m high on center

1.76m high on ends

Black powder coat finish

**Frame - Sides & Bottom**

50 x 50 x 2 mm Tube

**Frame - Top Horizontal**

30 x 50 x 1.2 mm Tube

**2nd Rail - Top & Bottom**

30x 50 x 1.2 mm Tube

Picket

25 x25 x 1.2 mm Tube

Picket Spacing 137 mm

# Drawings

## 12FT PLAIN

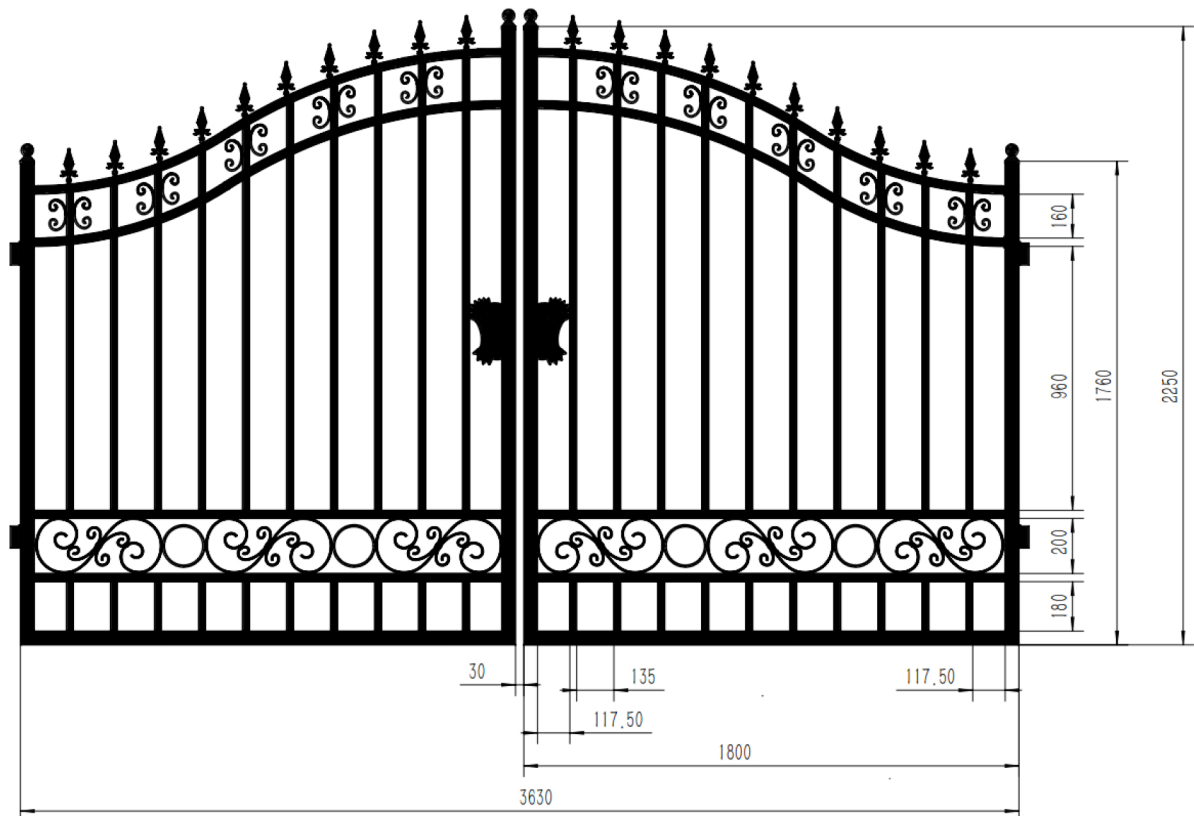

## 14FT-DEER

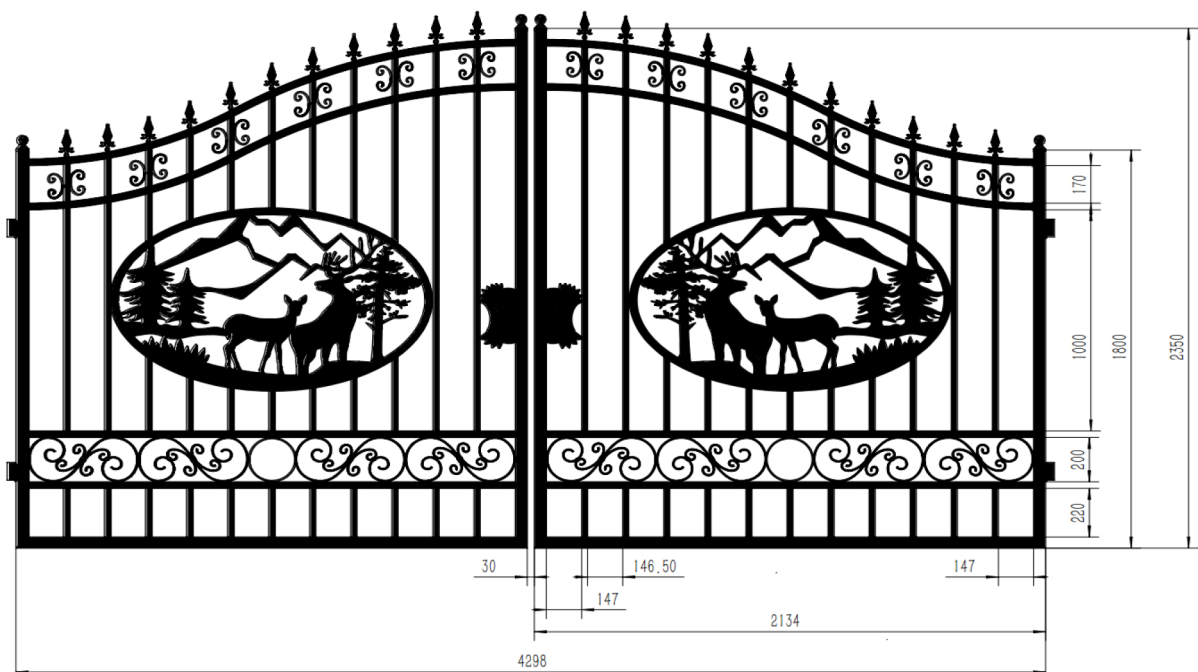

# 16FT-PLAIN

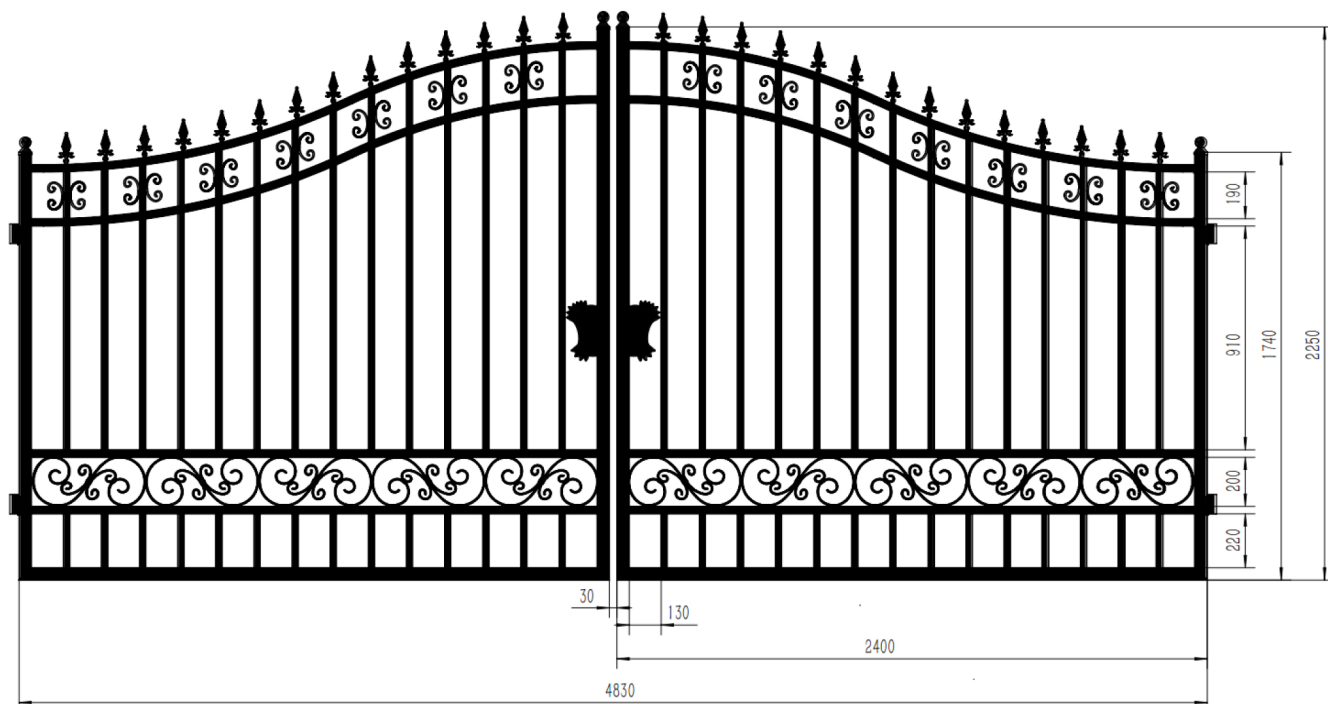

# 18FT- HORSE

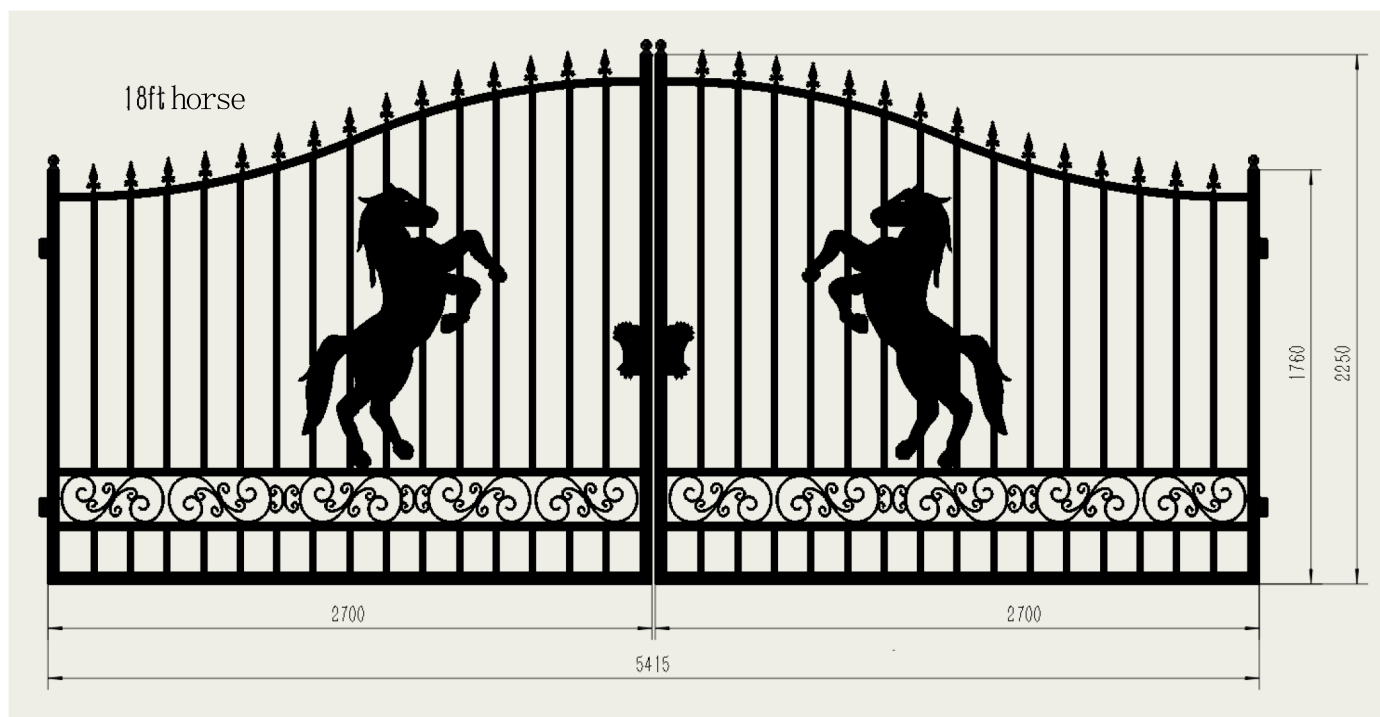

# 20FT-LOVER

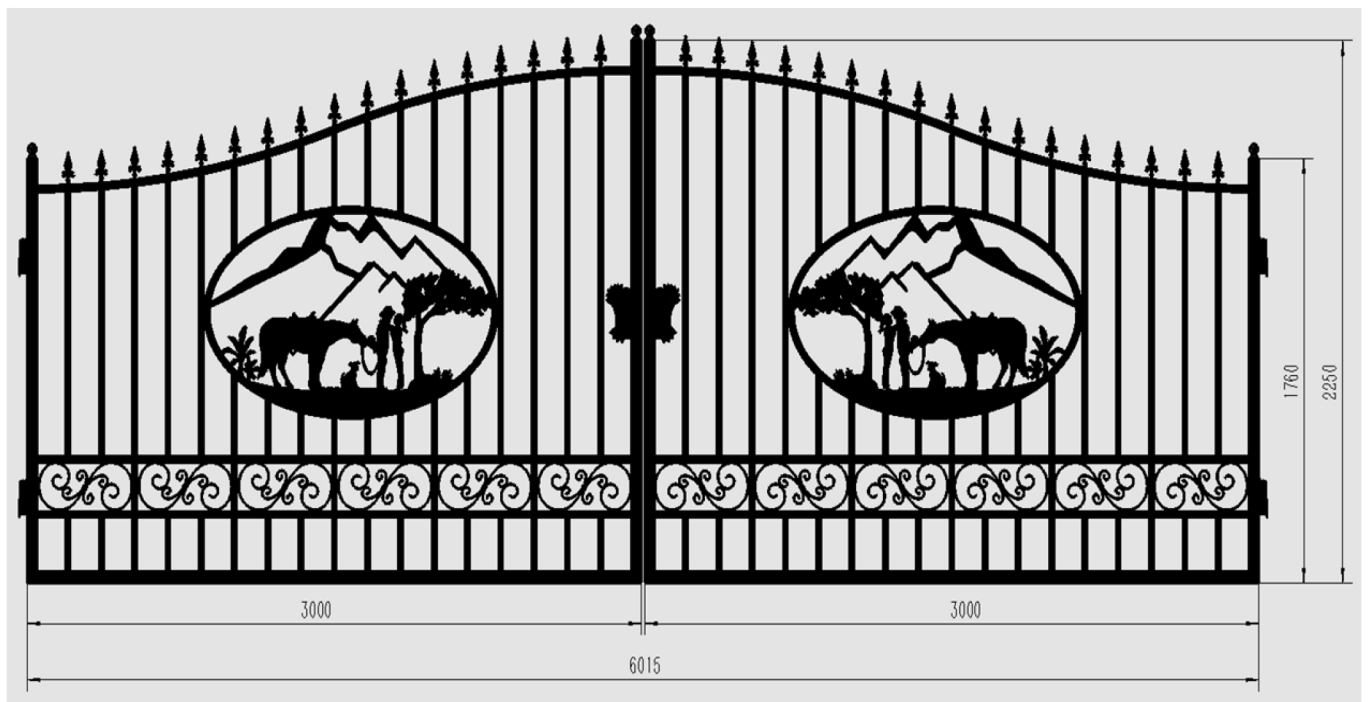

# 20FT-HORSE



# 20FT KAPOK

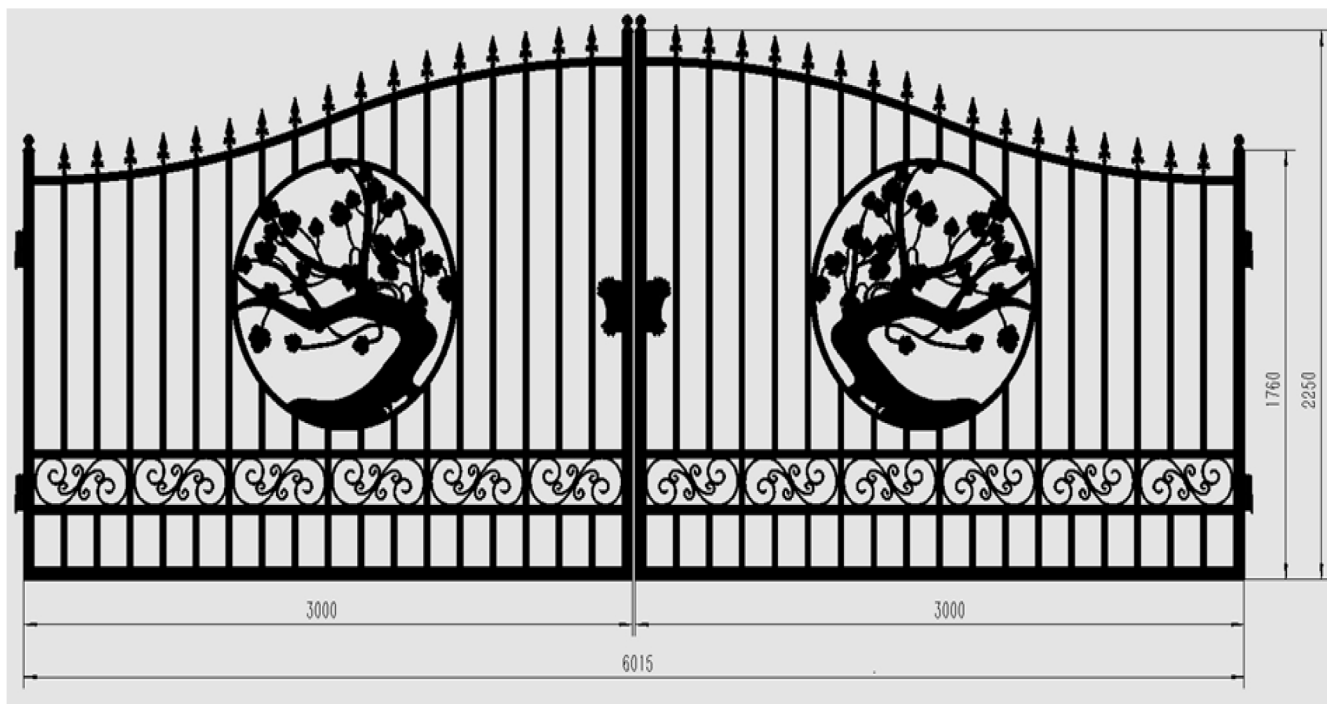

# 20FT PLAIN

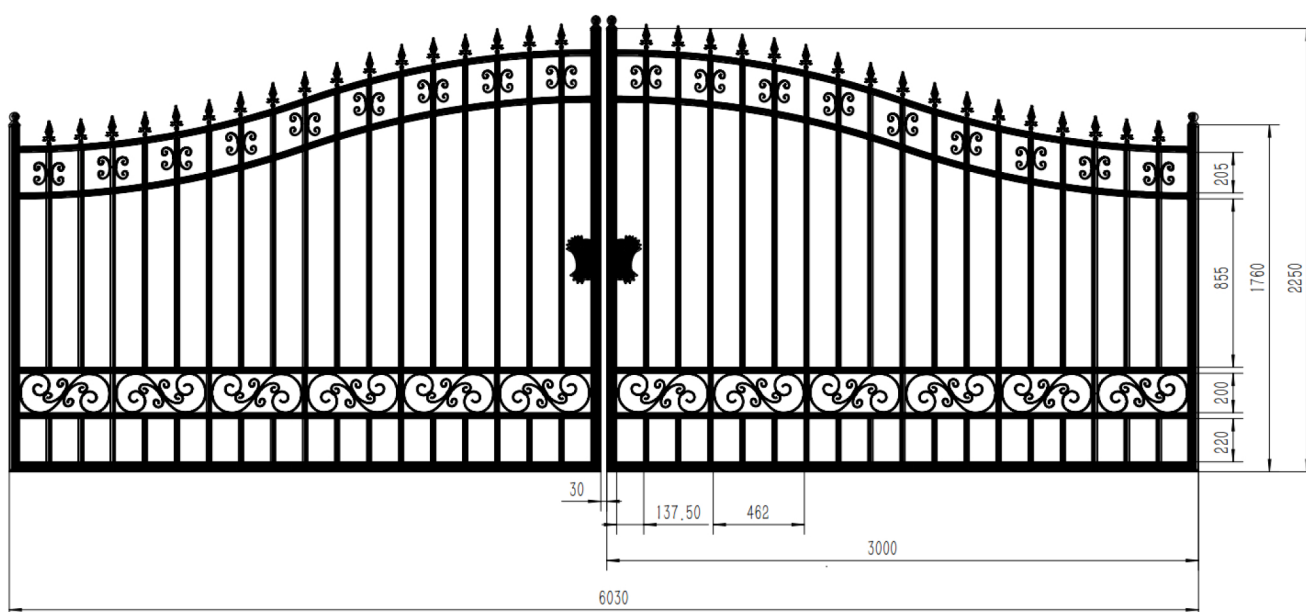

# THINK SAFETY, EVERYDAY!

## WARNING

For safe operation, read these rules and instructions carefully to avoid accidents that could result in Death or Serious Injury.

## TO THE OWNER/OPERATOR

Please read this manual "before" unpacking or using this product for the first time. This manual provides you with the necessary instructions to safely install and use your purchase. Do not let other people use this attachment without first being instructed how to safely use it.

## WARNING

## SAFETY TIPS

Always wear proper safety equipment such as safety glasses and gloves  
If you need to cut the threaded rods, always use a hacksaw.

## WARNING

# SAVE THIS MANUAL FOR FUTURE REFERENCE!

---

# Choose the right Post

## Setting the Post in Soil or Gravel

1

Try this method if you have dense soil. You can install your posts directly into the soil as long as it's dense and has good drainage. The installation is more labor-intensive and a bit less stable than concrete, but also cheaper and (often) more decay-resistant.

- Due to additional strain, gate posts work better when installed in concrete.

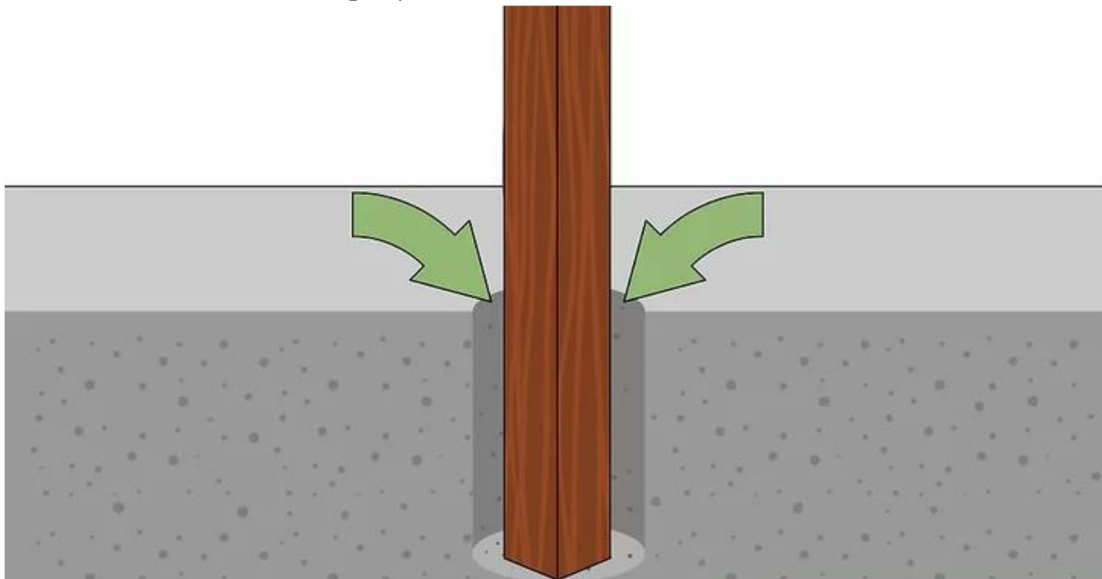

2

Choose a durable fence post. Follow local advice if possible, since climate and availability will affect this decision. Unless you live in a desert, it pays to choose durable lumber, which comes in **three** varieties:

- Our steel post with hinge

Our Steel posts are the perfect choice for a smart, clean and long lasting maintenance free installation.

The posts go through a galvanising process first to resist rusting and are then spray finished in a satin black.

With adjustable hinge mounting hardware to allow for any height gate to be hung at any chosen height - these posts are the most versatile steel posts on the market.

Being hollow also means that installing electric lighting or an automation system is a breeze as all cables can run up it inside of each post.

Gates can be mounted on the rear or in between the posts therefore adapting to any of your requirements.

Finished with an ornate composite capping top make these posts the premium choice in the range.

- Posts made entirely from durable heartwood. Western juniper, black locust, and Osage-orange are excellent choices. Pacific yew, redwood, and most cedar and white oak species can last 20+ years in most conditions.
- Pressure-treated wood with about 1 inch (2.5cm) sapwood surrounding a core of heartwood. Aspen, ponderosa pine, lodgepole pine, and Douglas fir are suitable examples. Buy this from a trusted source to avoid poorly treated wood.
- *Note*— All lumber should be labeled as suitable for ground contact. Not all pressure-treated wood is intended for burial.

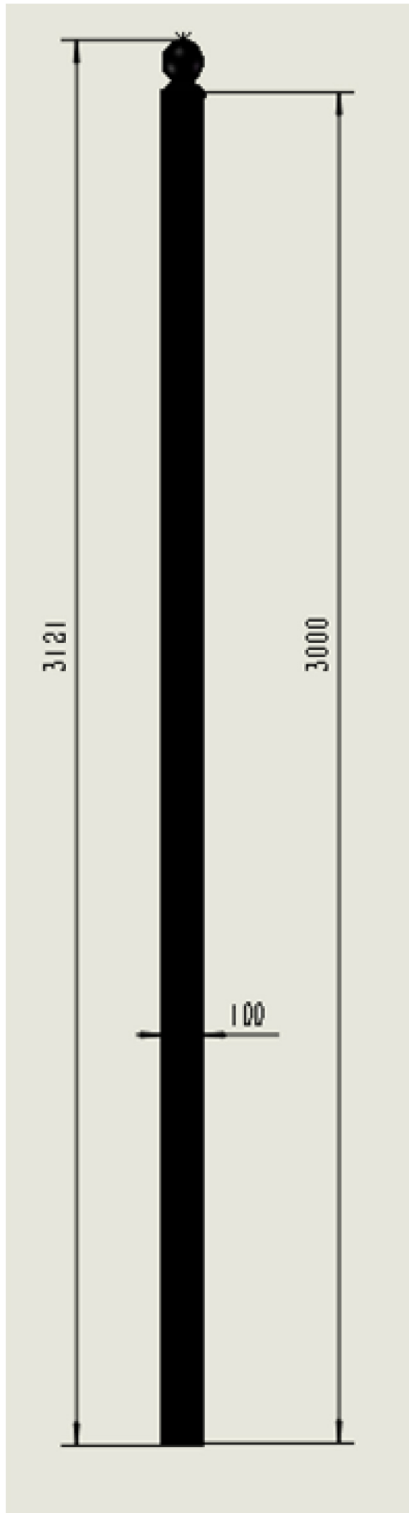

POST



## HINGS WITH PIN

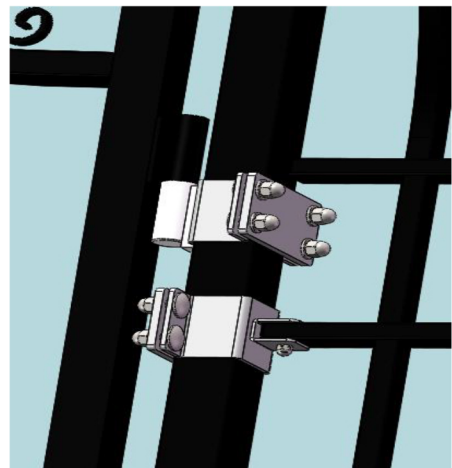
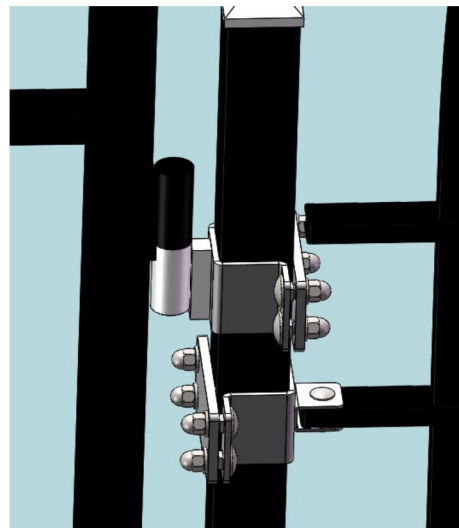

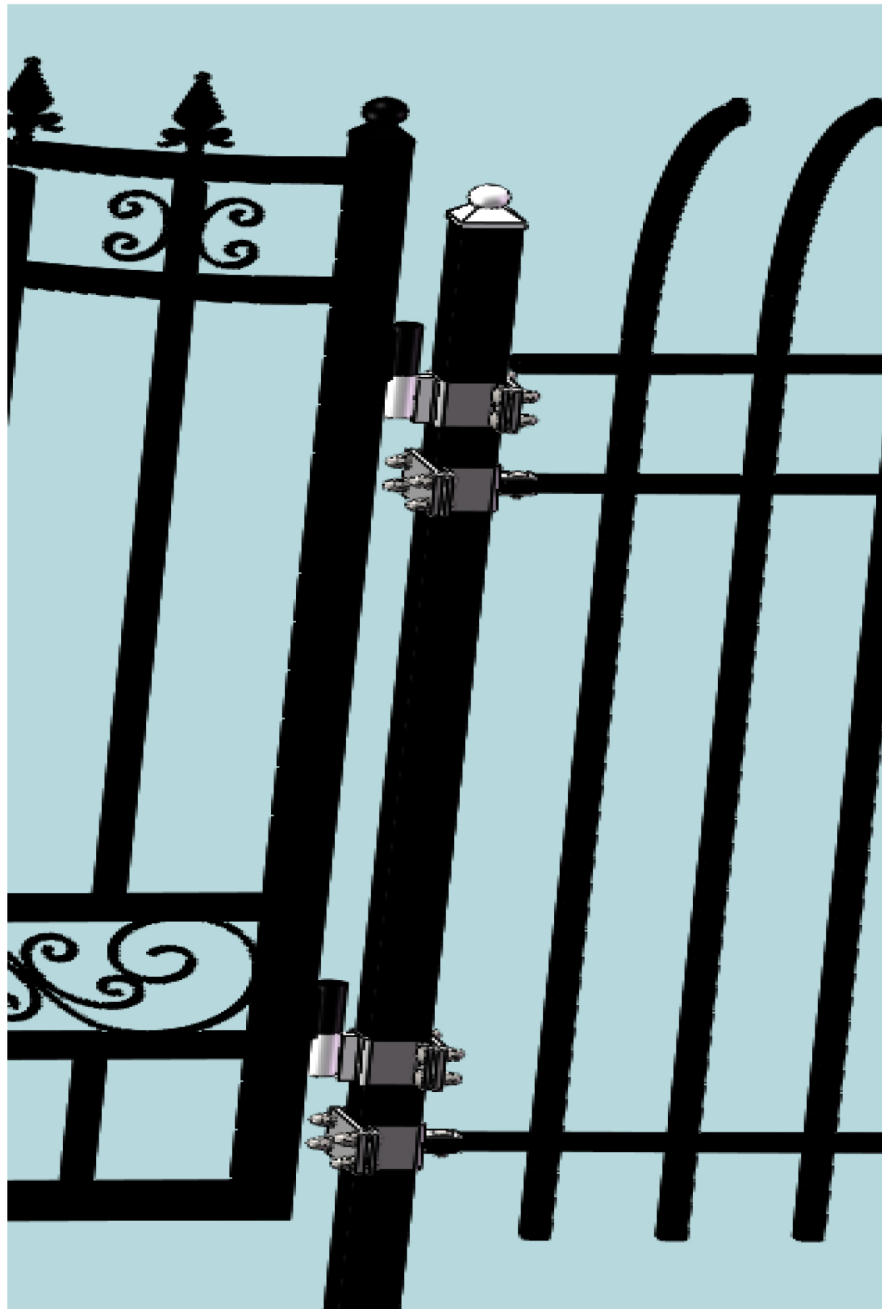

### 3

**Prep the wood against moisture (optional).** The sawn-off ends of the fence post are vulnerable to moisture. Consider these precautions if you live in a damp climate:

- Bevel the top of the fence post to a 45° angle to encourage rain runoff, or plan on installing a post cap.
- Treat the two ends with a non-water-based, brush-on wood preservative, such as copper naphthenate. Wood preservatives are toxic, so follow safety recommendations on the label. Apply multiple coats of the copper naphthenate and make sure to let it dry for 24 hours after each application.

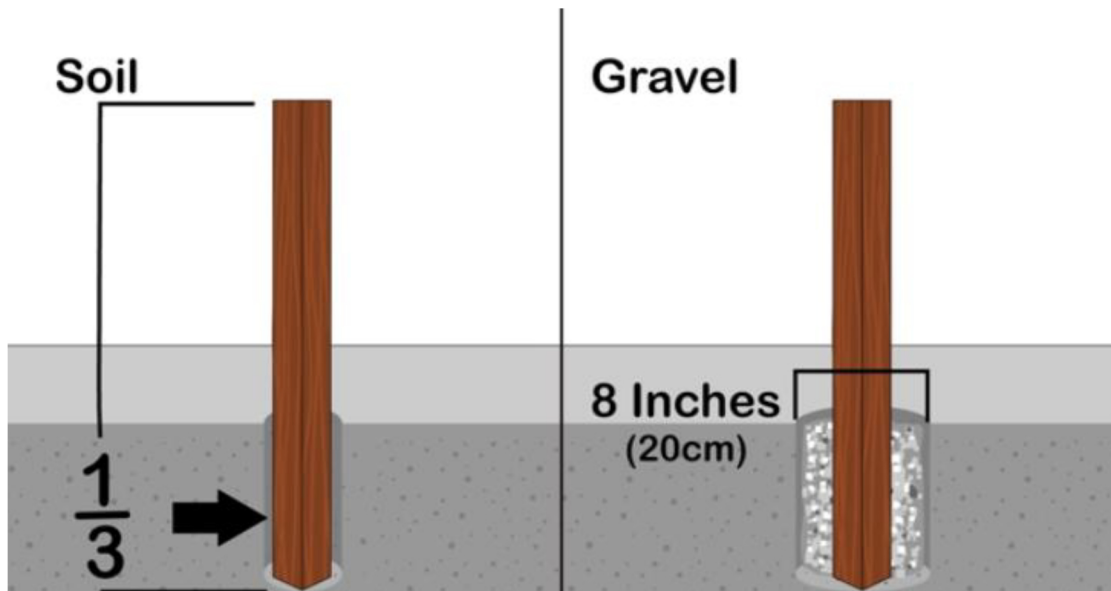

## 4

**Dig the hole.** As a general rule, an 8 foot post needs to be placed so that two feet of it are in the ground. If you plan to anchor the post in soil, the hole diameter should be as close to the fence post size as possible. If you plan to anchor the post in gravel, dig a bit wider — roughly 8 inches (20cm) across for a standard 4x4 post.

- Use a post hole digger to dig a straight-walled hole. If the soil is hard, cut through the sod with a shovel and/or let water soak into the dirt.
- Keep some dirt (or dirt mixed with gravel) nearby to backfill the hole.

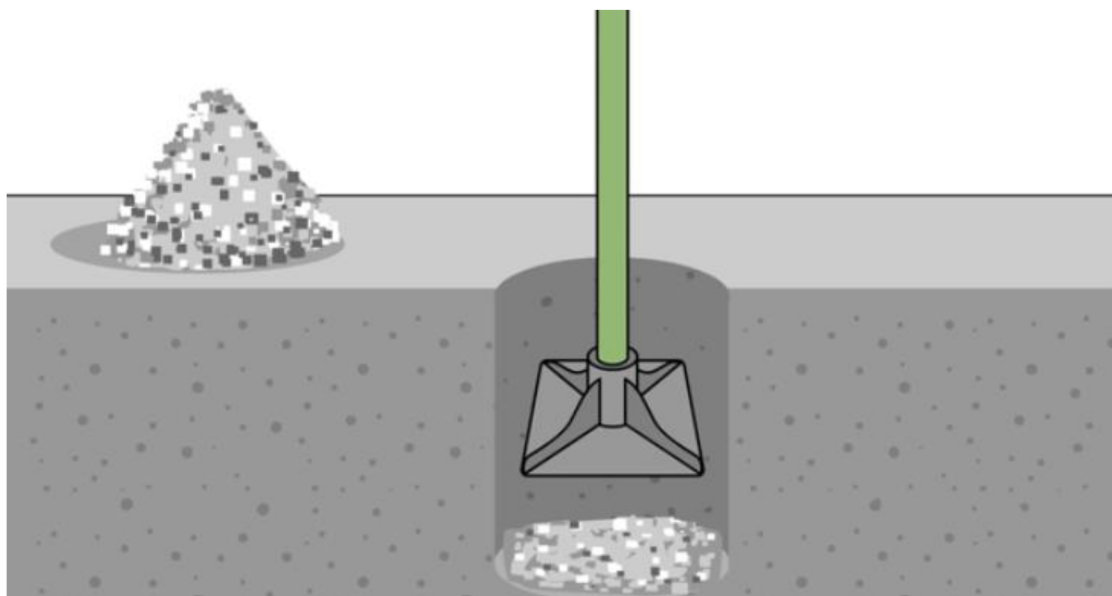

## 5

**Drop gravel into the hole.** A couple inches (few centimeters) of pea gravel or crushed stone improves soil drainage. Tamp it down well. This is especially important if your soil has poor drainage.

- You can use a wooden stick or broken wood tool handle as a tamping bar, or a piece of scrap lumber.

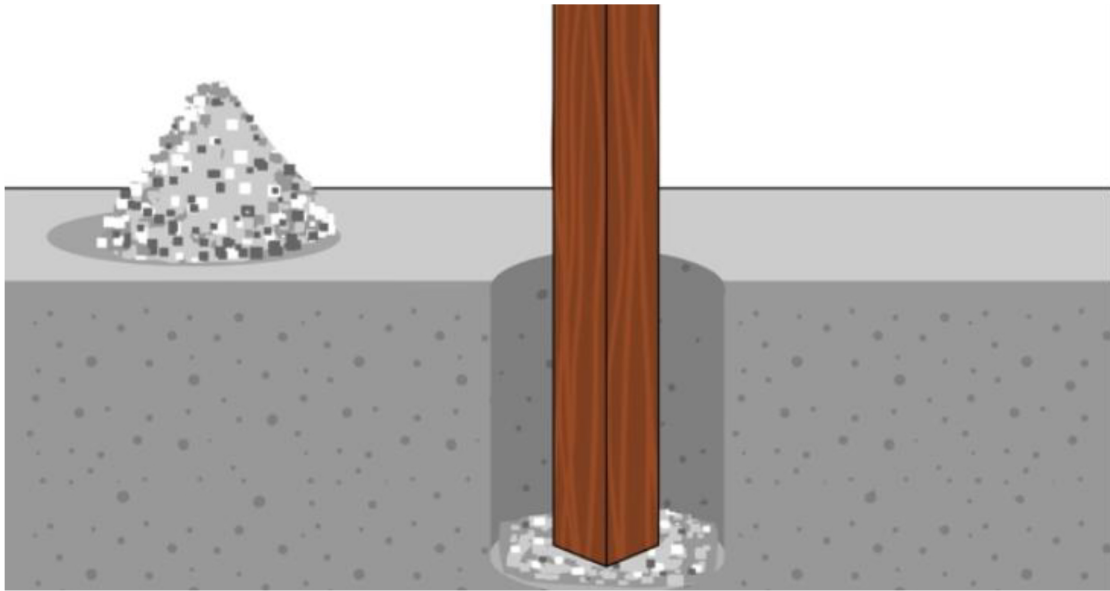

## 6

**Position the post in the hole.** Center the post in the hole, and get it level and in line with the other posts. An assistant will be useful to hold this in place during installation. However, if you are going to yourself have some 1" x 4" x 4' or longer material available. Then, drive wooden stakes into the ground on two sides and attach them with screws to the 1" x 4" to brace for "plumbing" (vertical level).

- Make sure that you measure the distance between your posts to ensure that the top and bottom rails will fit.

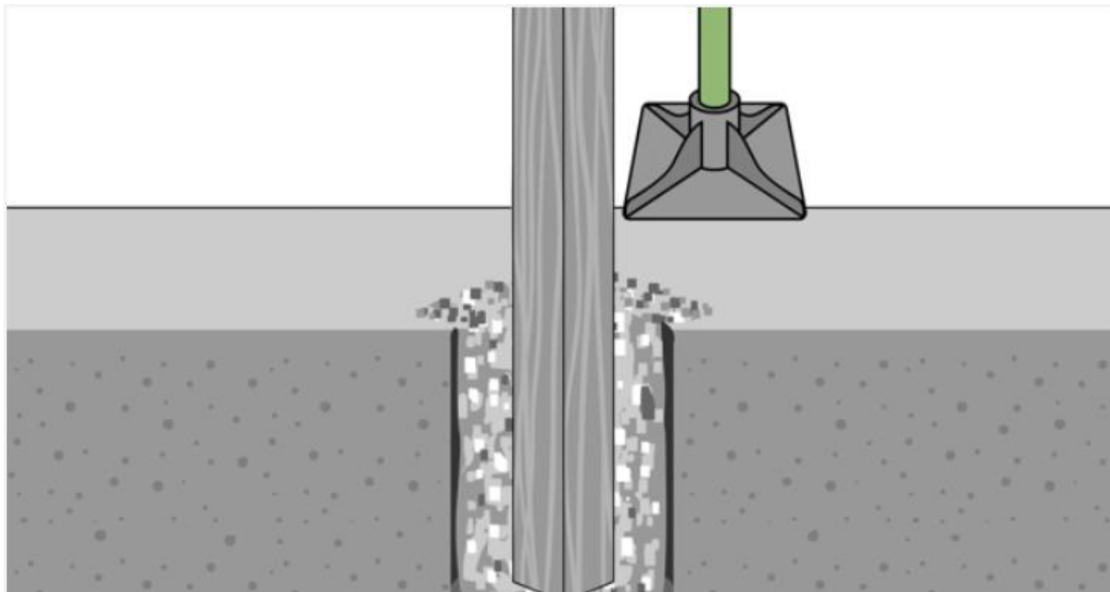

## 7

**Fill the hole with tamped crushed stone or soil.** Crushed stone offers better drainage than soil, and may improve stability as well if well tamped and installed in dense soil. Whether using crushed stone or ordinary soil, shovel it in 3–5 inches (7.5–12.5cm) at a time, tamping well after each batch.[3] Repeat until the hole is filled.

- Before each tamping, hold a level against the post and adjust until level.
- If you'd like to plant grass at the base of the post, use soil for the last couple inches (several cm), not gravel.



8

**Finish with a small hillock.** Build up the soil at the base of the pole to make a small "hill" sloping away from the post in all directions. The spot where the post leaves the ground is the most common location for rot. Good drainage here is extremely important.

## Setting the Post with Concrete

1

**Set posts in concrete when stability is extra important.** Concrete may be necessary if you are installing a fence in sandy soil, or in very soft, muddy soil. It's also a good idea when installing gate posts to provide extra stability. The main downside to concrete is its ability to trap water around the post. This can reduce the lifespan of the post by many years. The installation described here avoids this problem with a gravel base and an open-bottomed concrete sleeve.

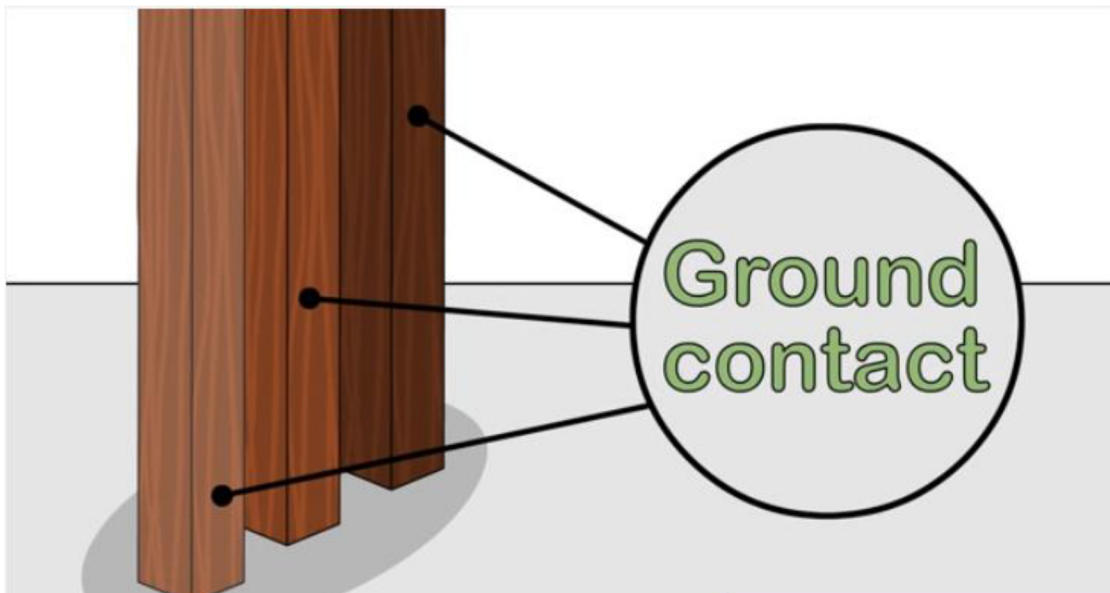

## 2

**Prepare your fence posts.** All fence posts should be made from durable lumber labeled for ground contact. For more information on selecting and prepping your fence posts, see the method above.

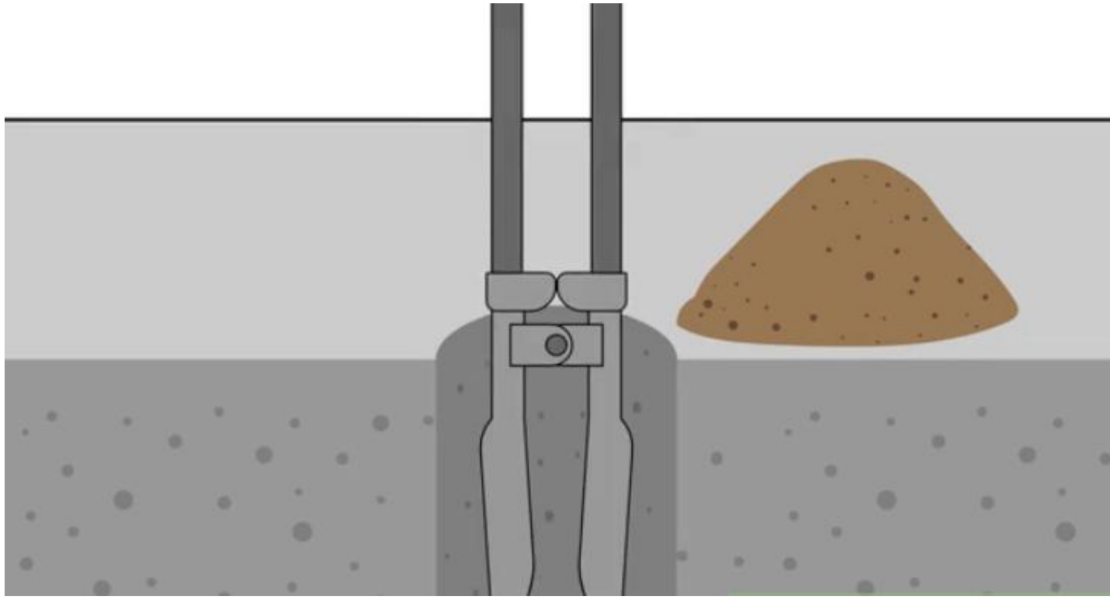

## 3

**Dig a hole wider than the fence post.** [4] A typical 4x4 fence post requires a concrete sleeve about 12 inches (30cm) across. Plan to bury  $\frac{1}{3}$  of the post, then allow a few inches (several cm) for the base beneath it. A large post hole digger or post driver will make this job much easier.

- Power tools can be dangerous if the soil is rocky. You may need to use a clamshell digger instead, plus a long digging bar to lever out rocks.
- The width of the hole should be consistent the whole way down, not cone shaped.
- 

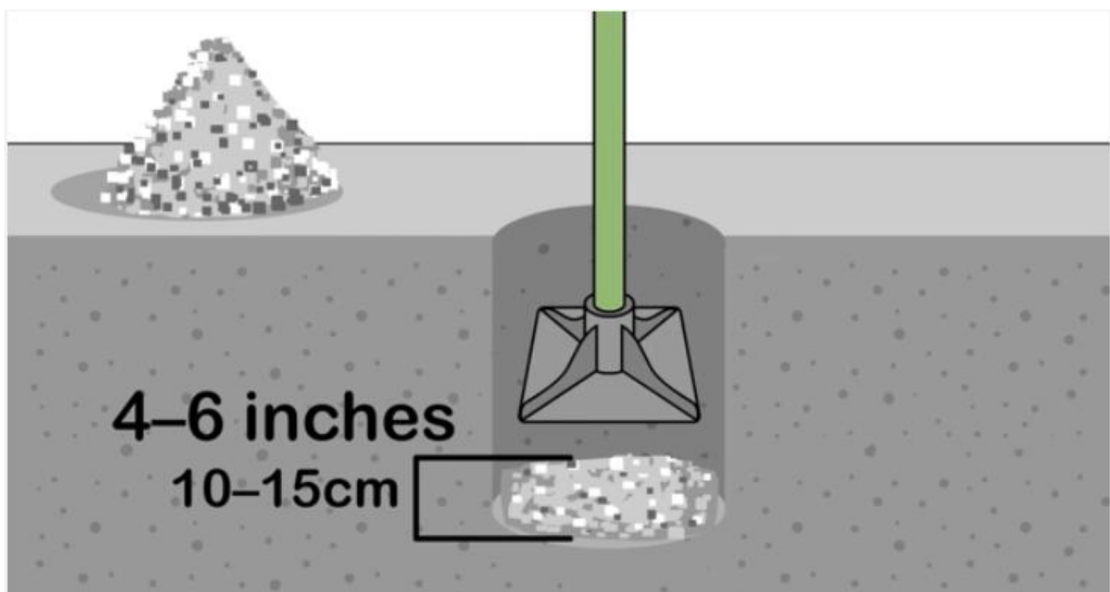

# 4

**Add a few inches of gravel.** A base of gravel or crushed stone will greatly improve drainage. Pour 4 to 6 inches (10 to 15cm) into the hole and tamp it level.

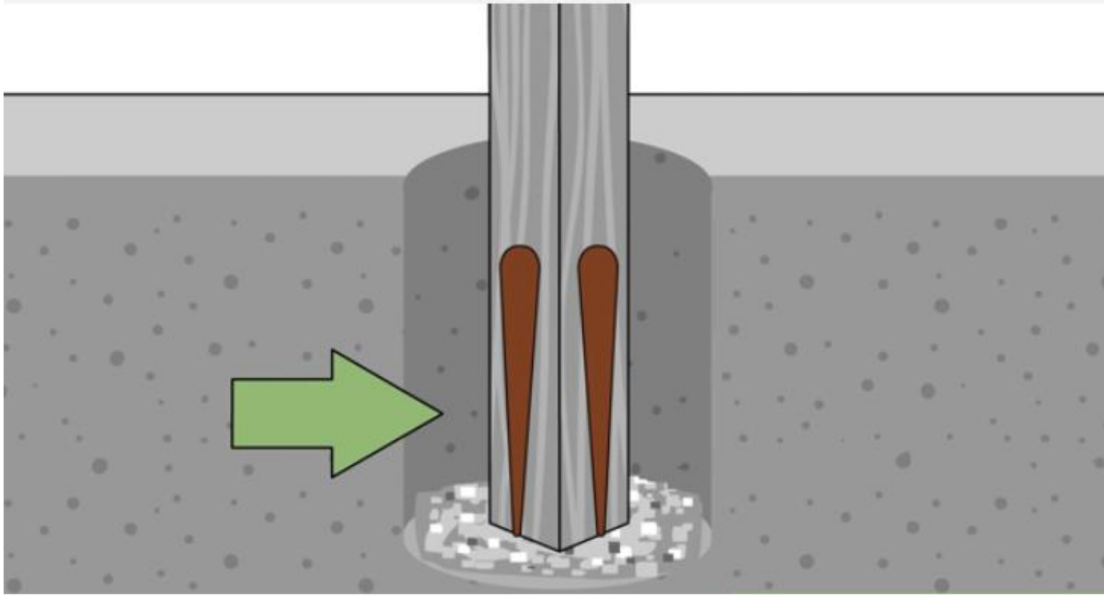

# 5

**Brace the post.** Position the post in the center of the hole, using a level to guide you to a vertical position. To hold the post in place, drop two stakes into the soil near two adjacent sides of the post. Nail or screw scrap lumber between the stake and the post. Don't pound the nails or screw the screws all the way into the post, so you can easily remove them later.

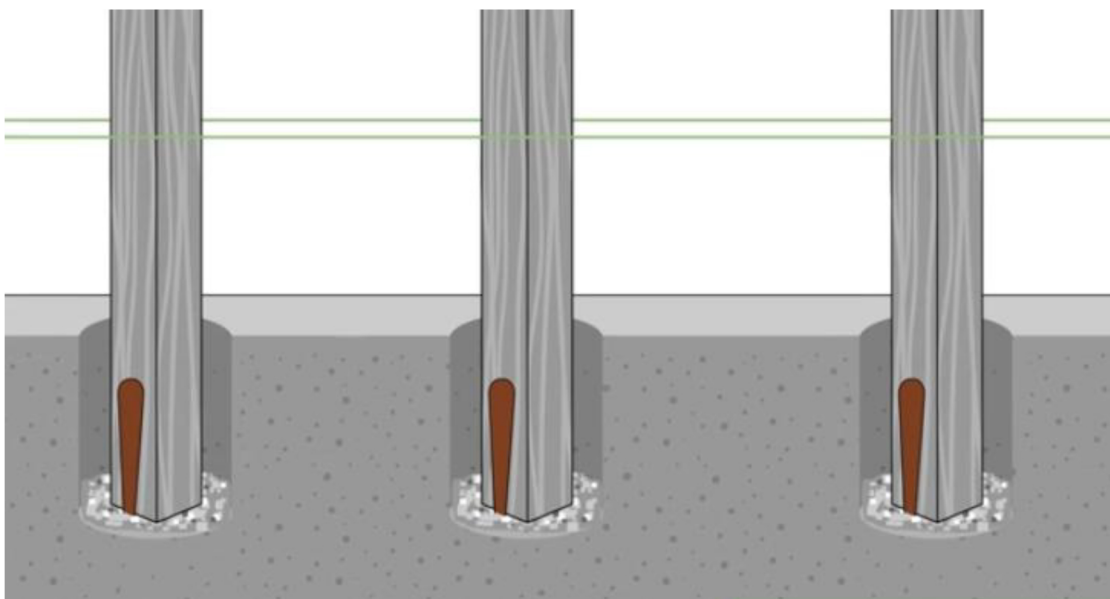

# 6

Repeat for each post hole. Dig every post hole and brace each post so you can pour the concrete all at once. Use a string between corner posts to ensure that all fence posts are in line with each other.

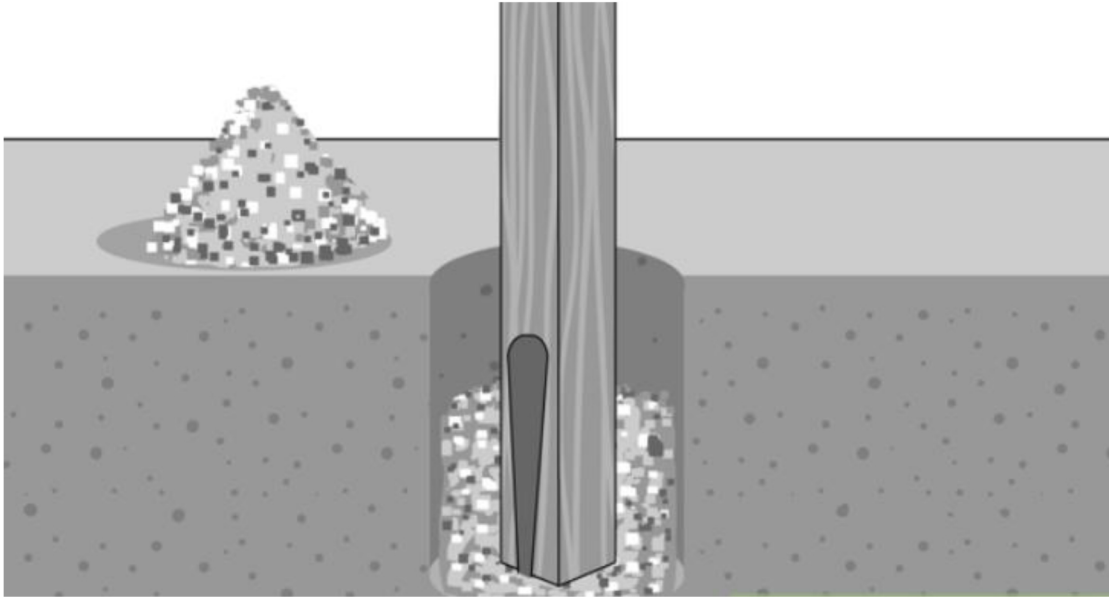

# 7

Add more gravel. Another layer of tamped gravel will further improve drainage.



# 8

**Mix your concrete.** Put on safety glasses and waterproof gloves.[5] Pour a full bag of concrete mix (or as much as you can transport) into your wheelbarrow and mix in about 90% of the recommended water according to the label. Mix for a few minutes to check the final consistency, then slowly add more water until the concrete feels like paste.[6]

- To save effort, you can rent a portable concrete mixer or the services of a concrete truck.
- To save money, make your own concrete mix: 1 part Portland cement, 2 parts sand, and 3 parts coarse gravel, by volume.[7]

- Some fast-setting concrete mixes can be poured in dry, then mixed with water in the hole. These mixes tend to be weaker and more expensive, so speed comes at a high price.[8]
- Be careful not to make the concrete too runny. Add the water in small increments until the concrete comes off of the shovel easily.

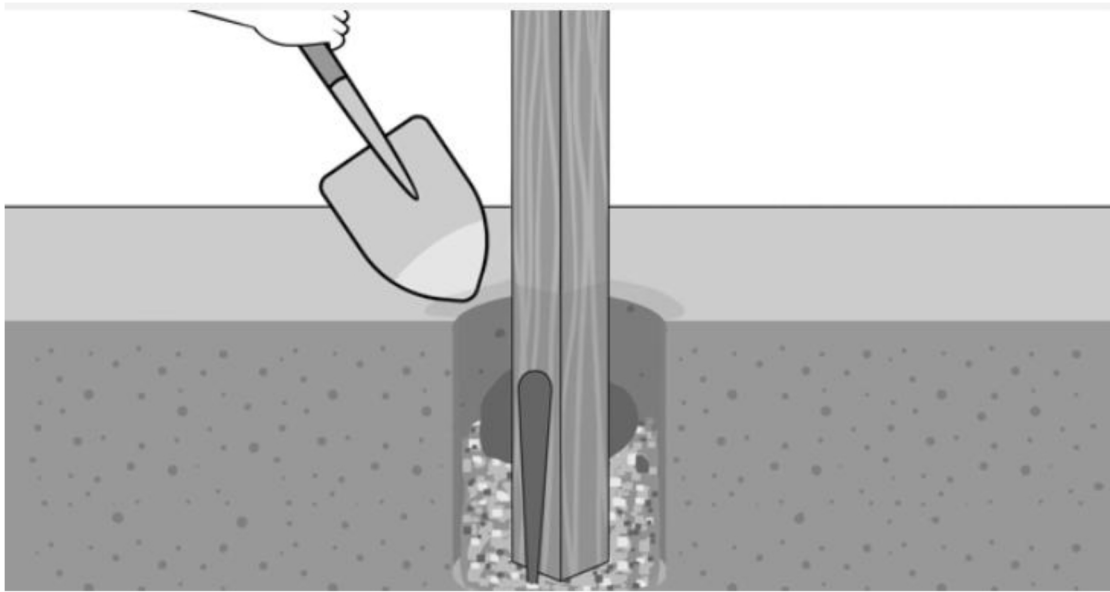

## 9

**Fill the hole with concrete.**[9] Shovel concrete into the hole up to soil level. Work quickly enough to use each batch of concrete before it hardens. Take care not to splash cement onto the post.

- Set a level on top of the post before the concrete dries to ensure it's straight

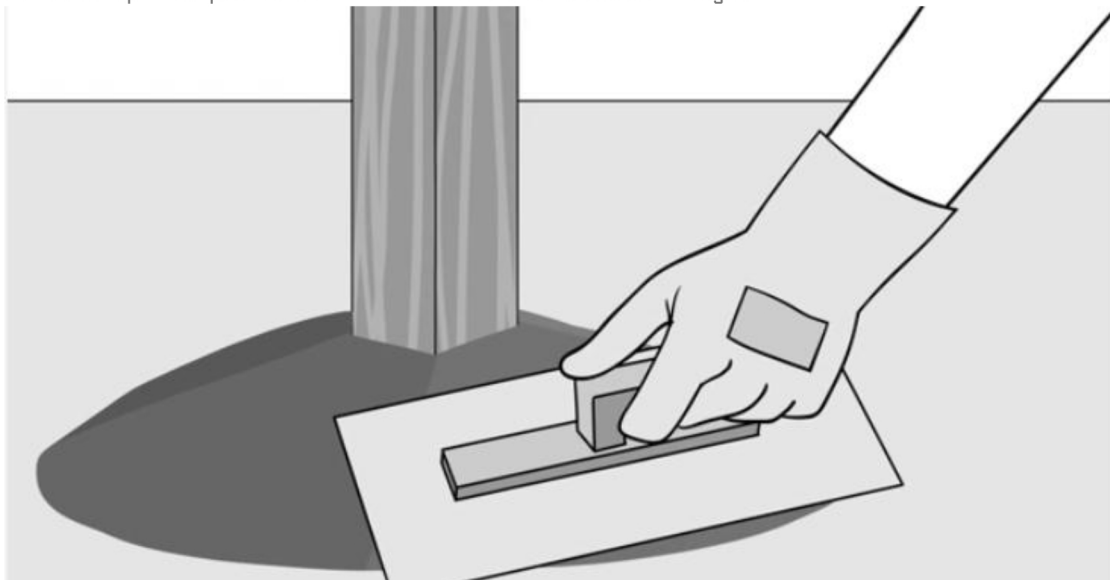

## 10

- **Trowel the concrete into a slope shape.** Smoothly cap off the top of the cement with a trowel, grading it outwards from the post. Aim for a slope roughly ½ inch (1.25cm) above ground level, dropping to about 1 inch (2.5cm) below ground level. This pitch will allow the water to flow off the post, preventing pools of water that promote decay.

# 11

Allow at least three days for the concrete to cure. Give the concrete some time to dry and harden before building the fence or putting any weight on the post.

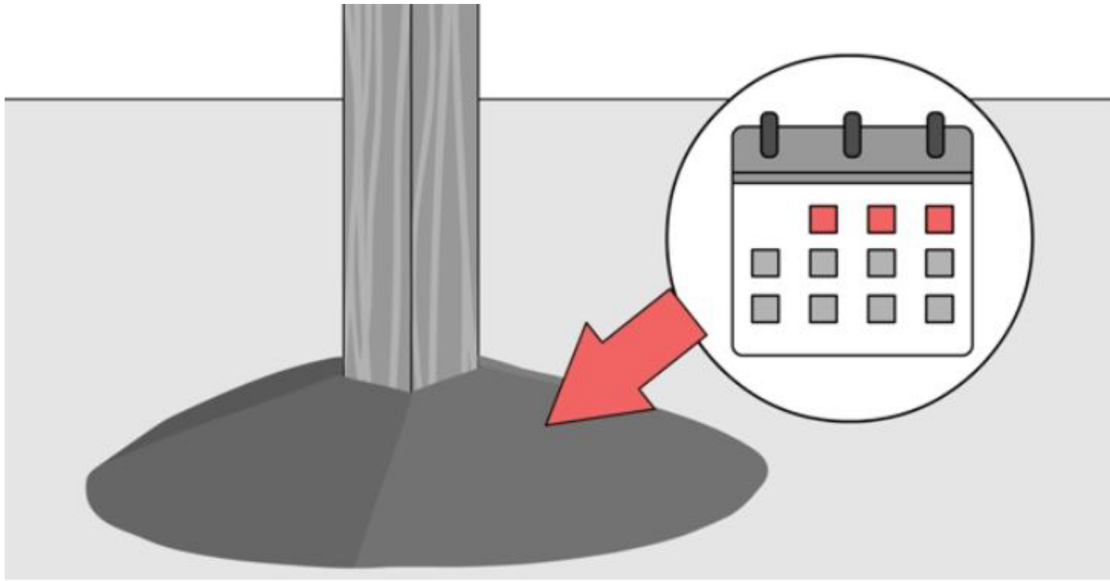

# 12

Seal the gap between post and concrete. Once the initial curing is complete, seal the gap around the base of the fence post. This gap will widen with natural expansion and frost, allowing water to pool here and cause rot. Seal it with a sealant that bonds to concrete and wood, such as some silicone sealants or exterior acrylic latex caulk.

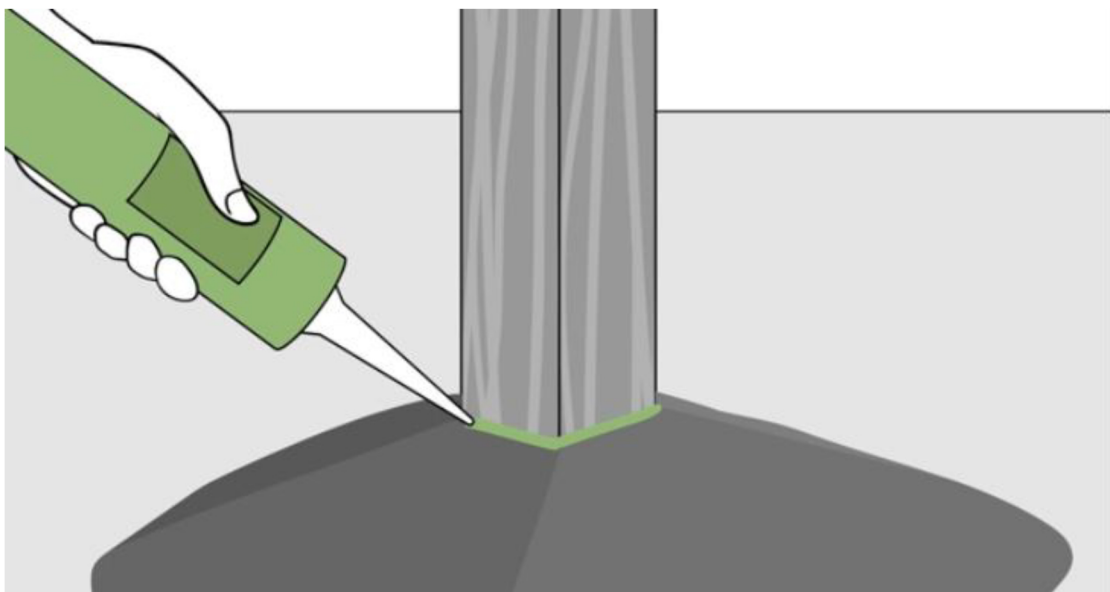

# Choose right Hinge with loops for the post and fix on the post

Gate with pin(Diameter 20mm)

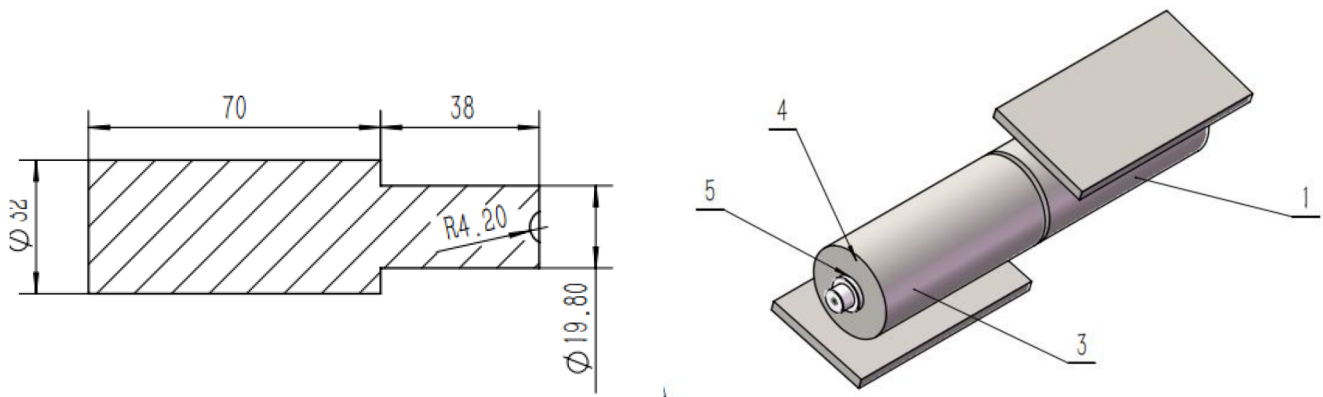

## Step 1 Fix the hinge loops

Fix the hinge loops-hardware on the post as shown on the picture.

## Step 2 Fix the left gate

Slid the gate with hinge pins onto the post with hinge loops, put the hinge pin into the two loops.

## Step 3 Fix the right gate

Repeat this process to fix the right gate on the right post

## Step 4 Review

Check everything again to make sure that all the parts are aligned so that they slip into place when the gate is closed.

# Now all the process is finished !